



FLATPOINT I LED



IP 68

[A]



[B]



[C]

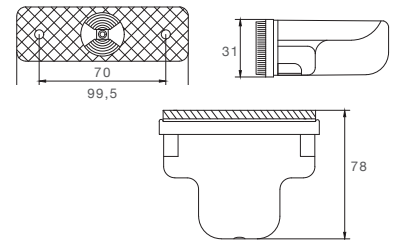
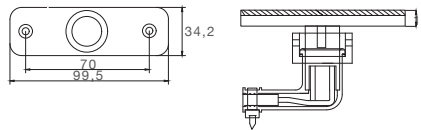
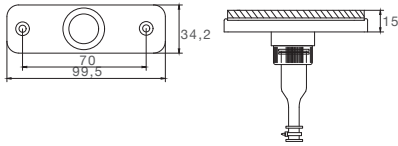

BEST. NR				ZUSATZ					ANSCHLUSS			
PART NO				ADD ON					CONNECTOR			
31-6604-014	1/-	LED	24V	[A] Bild				P&R			0,50 m	
31-6604-034	1/-	LED	24V	[A]				P&R			1,50 m	
31-6604-074	1/-	LED	24V	[B] Bild				P&R			0,50 m	
31-6604-094	1/-	LED	24V	[B]				P&R			1,50 m	
31-6604-114	-/-	LED	24V	[B]				P&R			3,50 m	
31-6607-004	-/-	LED	24V	[B] Bild				2 pol. ASS2 2 pin ASS2			1,50 m	
31-6607-054	-/-	LED	24V	[A] Bild				2 pol. ASS3 2 pin ASS3			1,50 m	
31-6614-014	1/-	LED	24V	[C] Bild				Schutzhaube protection cap	P&R		0,50 m	
31-6614-034	1/-	LED	24V	[C]				Schutzhaube protection cap	P&R		1,50 m	
31-6614-074	1/-	LED	24V	[D] Bild				Schutzhaube protection cap	P&R		0,50 m	
31-6614-094	1/-	LED	24V	[D]				Schutzhaube protection cap	P&R		1,50 m	
31-6664-014	1/-	LED	24V	[E] Bild				Schutzhaube protection cap	P&R		0,50 m	
31-6664-031	1/-	LED	24V	[E]				Schutzhaube protection cap	P&R		1,50 m	
31-6667-014	-/-	LED	24V	[D] Bild				Schutzhaube protection cap	2 pol. ASS3 2 pin ASS3		0,50 m	



FLATPOINT I LED

ADR Zone 2

IP 68

[D]

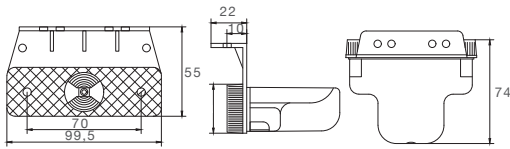

[E]

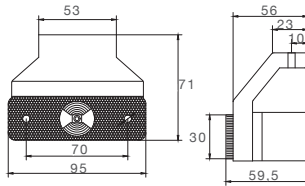

[F]

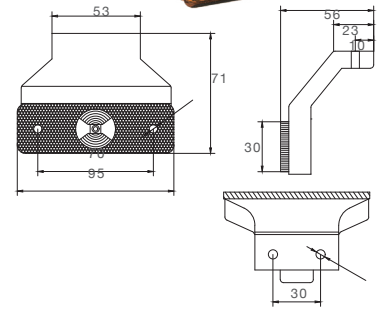

Positionslampe
Position Lamp

BEST. NR				ZUSATZ	ANSCHLUSS	
PART NO				ADD ON	CONNECTOR	
31-2204-014	1/-	LED	24V	[A] Bild	P&R	0,50 m
31-2214-004	1/-	LED	24V	[D] Bild Schutzhaube protection cap	P&R	0,25 m
31-2214-014	1/-	LED	24V	[D] Schutzhaube protection cap	P&R	0,50 m
31-2214-024	1/-	LED	24V	[D] Schutzhaube protection cap	P&R	1,00 m
31-2214-034	1/-	LED	24V	[D] Schutzhaube protection cap	P&R	1,50 m
31-2214-114	1/-	LED	24V	[C] Schutzhaube protection cap	P&R	0,50 m
31-2214-134	1/-	LED	24V	[C] Schutzhaube protection cap	P&R	1,50 m
31-2264-014	1/-	LED	24V	[F] Bild	P&R	0,50 m
31-2264-024	1/-	LED	24V	[F]	P&R	1,00 m
31-2264-034	1/-	LED	24V	[F]	P&R	1,50 m
31-2267-014	1/-	LED	24V	[E] Bild Schutzhaube protection cap	2 pol. ASS2 2 pin ASS2	1,00 m
31-2267-064	-/-	LED	24V	[C] Bild Schutzhaube protection cap	3 pol. ASS3 3 pin ASS3	1,50 m
31-2267-074	-/-	LED	24V	[D] Bild Schutzhaube protection cap	3 pol. ASS3 3 pin ASS3	1,50 m
31-2267-084	-/-	LED	24V	[E] Bild Schutzhaube protection cap	3 pol. ASS3 3 pin ASS3	1,50 m



FLATPOINT I LED

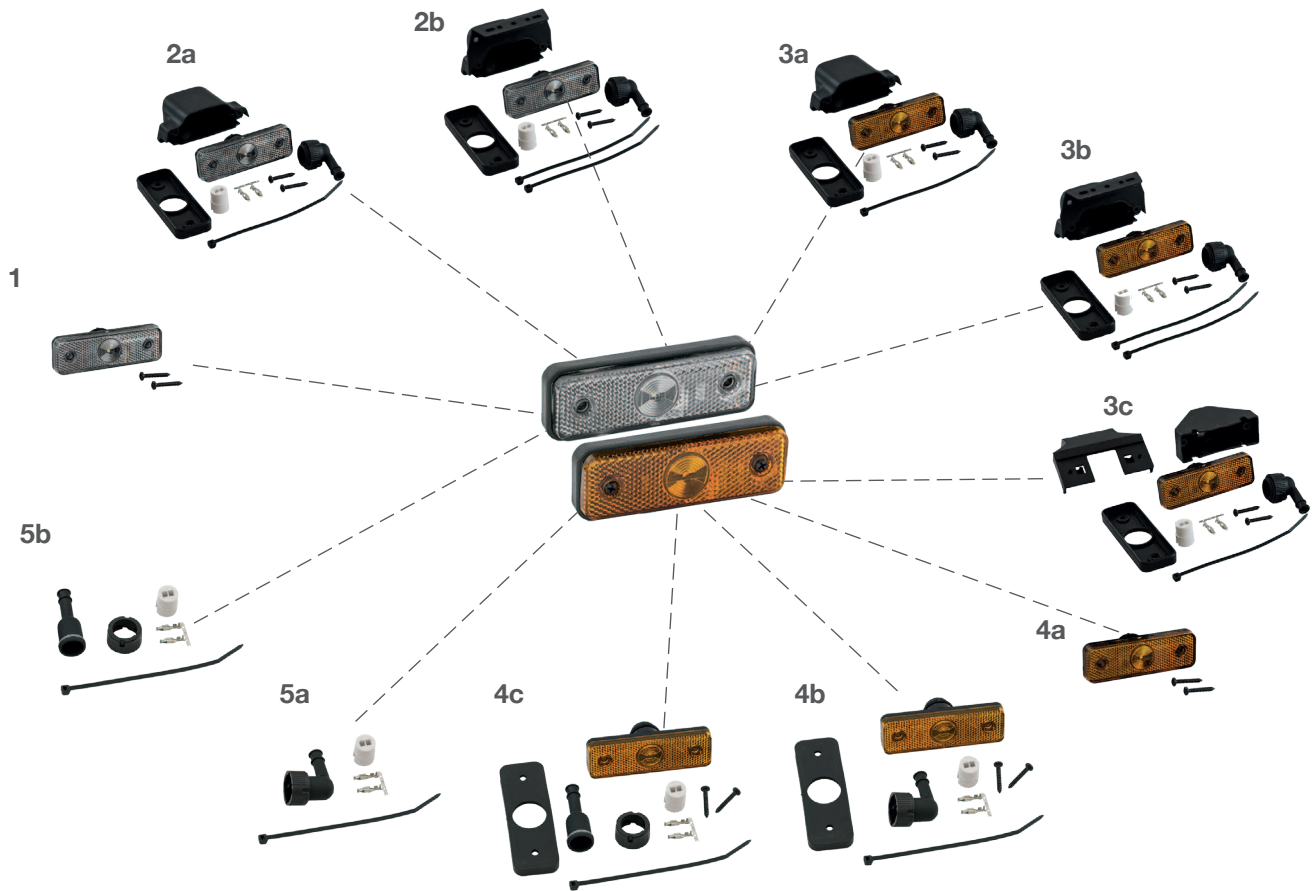

1 Ersatzleuchte weiß ohne Schutzhaube |
spare part lamp white without protection cap
mit Schrauben
with screws..... 21-6600-014

2 Ersatzleuchte weiß mit Schutzhaube |
spare part lamp white with protection cap
(a) mit 90° Anschluss ohne Haltewinkel
with 90° connector without bracket
..... 21-6601-004
(b) mit 90° Anschluss und 90° Haltewinkel
with 90° connector and 90° bracket
..... 21-6600-004

3 Ersatzleuchte orange mit Schutzhaube |
spare part lamp orange with protection cap
(a) mit 90° Anschluss ohne Haltewinkel
with 90° connector without bracket
..... 21-2201-004
(b) mit 90° Anschluss und 90° Haltewinkel
with 90° connector and 90° bracket
..... 21-2200-014
(c) mit 90° Anschluss und 90° Haltewinkel schräg
with 90° connector and sloping 90° bracket
..... 21-2202-004

4 Ersatzleuchte orange ohne Schutzhaube |
spare part lamp orange without protection cap
(a) mit Schrauben
with screws..... 21-2200-004
(b) mit 90° Anschluss
with 90° connector
..... 21-2201-014
(c) mit geradem Anschluss
with straight connector
..... 21-2201-044

5 Anschluss | connector
(a) 90° gewinkelt
angled connection 90°
..... 15-2122-104
(b) gerade komplett
straight bracket complete
..... 15-2122-124

6 ASS1 & ASS2 Verbinder |
ASS1 & ASS2 connector
(a) 2 pol. männlich
2 pin male 13-5625-991
(b) 2 pol. weiblich
2 pin female 13-5626-401





FLATPOINT | LED

ZUBEHÖR / ACCESSORIES

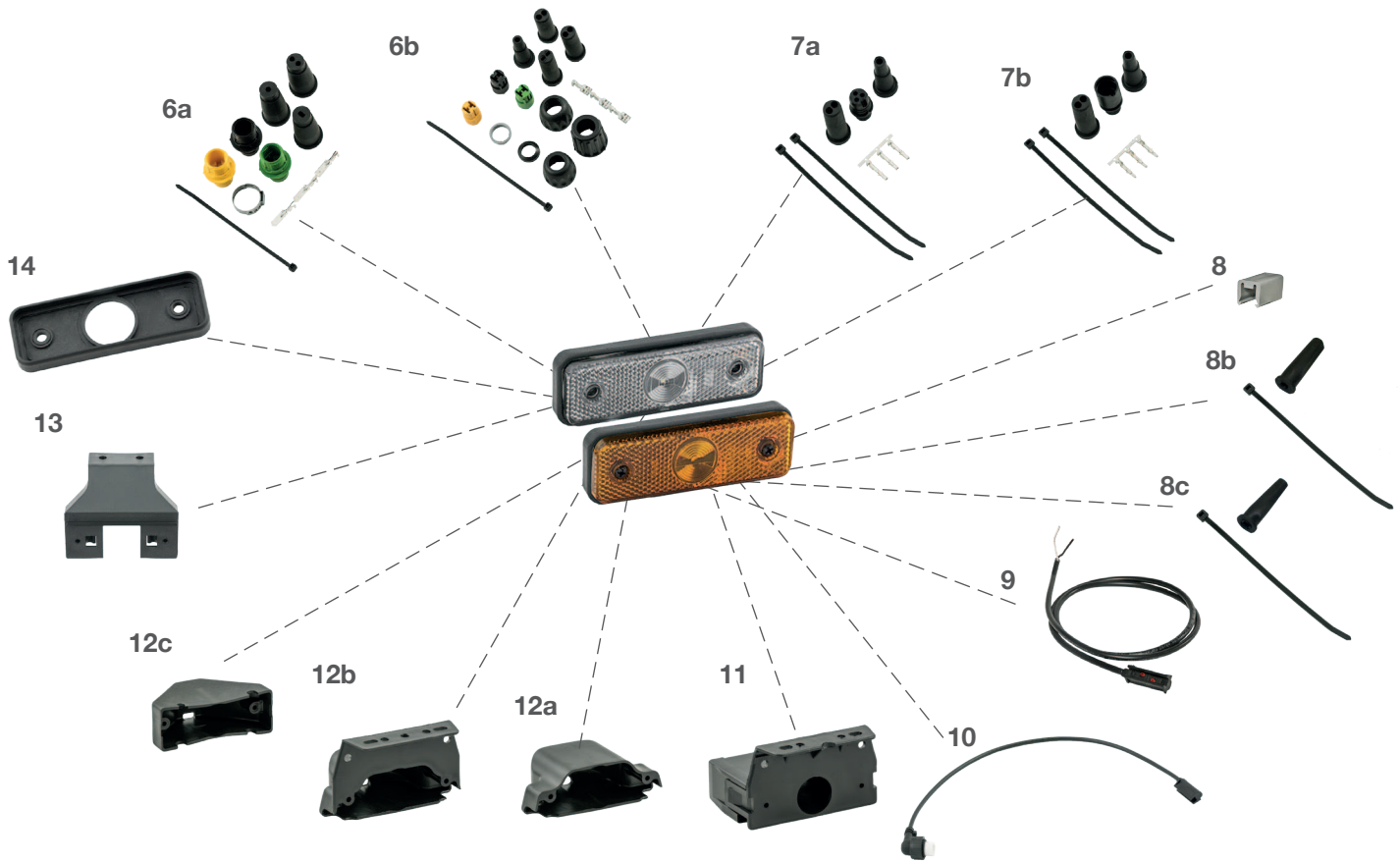

7 ASS3 Verbinder | ASS3 connector

- (a) 3 pol. weiblich
3 pin female 13-0322-281
- (b) 3 pol. männlich
3 pin male 13-0332-281

8 für P&R Verbinder |
for P&R connector

- (a) Verschlusskappen
caps 15-5971-014
- (b) Endkappen rund
end caps round 15-5983-024
- (c) Endkappen eckig
end caps square 15-5729-014

9 Anschlusskabel P&R |
connection cable P&R

- 0,50 m 68-5000-014
- 1,50 m 68-5000-034

10 Zuleitung P&R |
front connection P&R

- 0,50 m 31-2204-154

11 Sockel mit Haltewinkel und Schutzhaube |
socket with bracket and protection cap

- 15-2128-274

12 Schutzhaube | protection cap

- (a) ohne Haltewinkel
without bracket 15-2122-164
- (b) mit 90° Haltewinkel
with 90° bracket 15-2122-174
- (c) für schrägen Haltewinkel
for sloping bracket 15-2128-094

13 Haltewinkel | bracket

- schräg
sloping 15-2128-144

14 Gummierunterlage | rubber base

- 11-2128-194