



aspoeck.com

POSIPOINT IV

LED
MEHRFUNKTIONSLEUCHTE

LED MULTIPLE FUNCTION
LAMP



A.PIERINGER GmbH

www.ap.works

2141 Ameis, Obere Hauptstraße 68

Telefon: +43 / 2425 / 278 00

E-Mail: vk@ap.co.at



PRODUCT INFO





POSIPOINT IV

LED MEHRFUNKTIONSLEUCHE
LED MULTIPLE FUNCTION LAMP

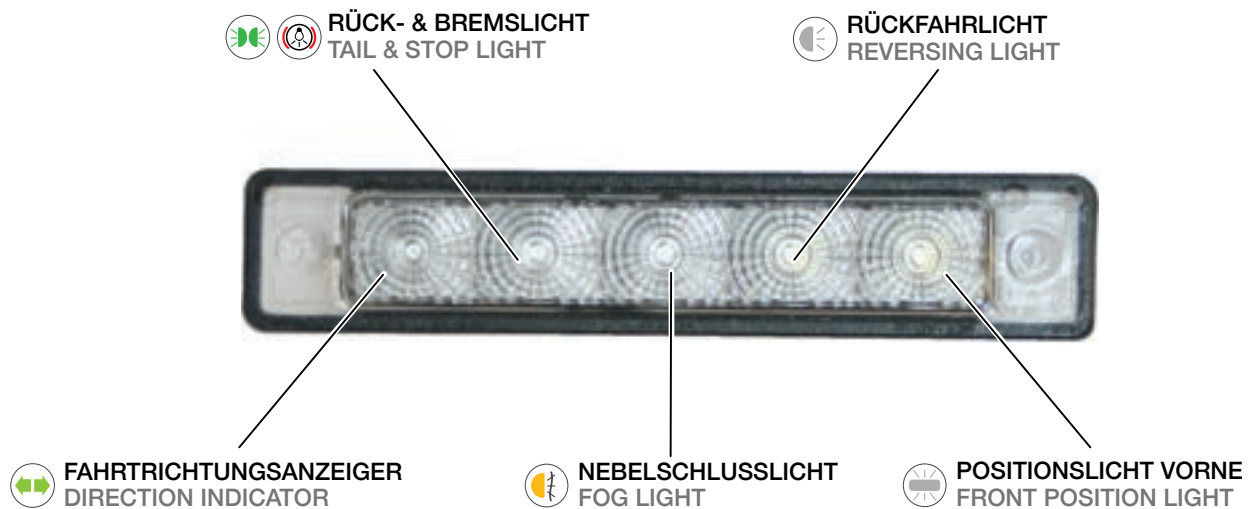

FEATURES

ADR Zone 2 IP6K9K



PLATZSPARENDER ANBAU DANK SCHLANKEM DESIGN
SPACE-SAVING MOUNTING THANKS TO SLIM DESIGN

HOHE IP-KLASSE IP6K9K
HIGH IP-CLASS IP6K9K

EINFACHE UND UNKOMPLIZIERTE MONTAGE
SIMPLE AND UNCOMPLICATED MOUNTING

OPTIONAL DUAL VOLTAGE











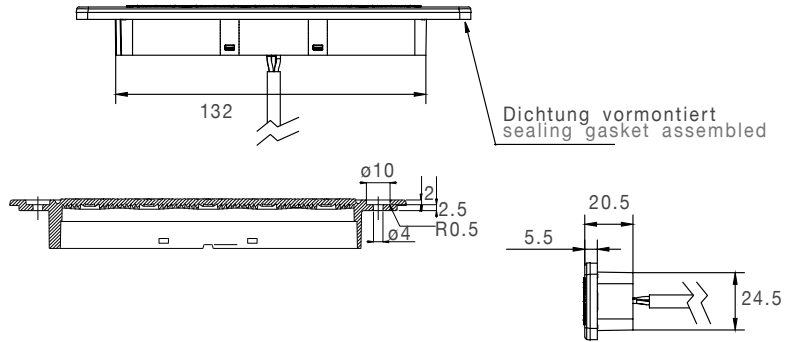
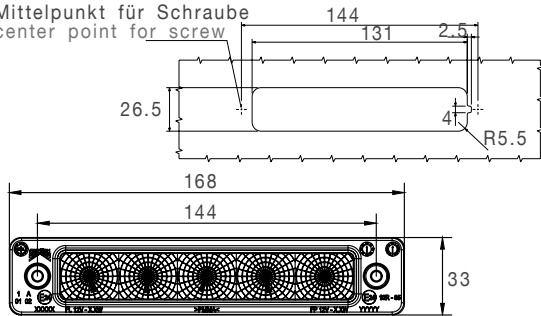















TECHNISCHE DATEN TECHNICAL FACTS			
VARIANTE: VERSION:	Fahrtrichtungsanzeiger + Positionsleuchte vorne <i>front direction indicator + position lamp</i>	Fahrtrichtungsanzeiger + Brems- leuchte + Schlussleuchte <i>direction indicator + stop lamp + tail lamp</i>	Nebelschlussleuchte + Rückfahr- scheinwerfer <i>fog lamp + reversing lamp</i>
NENNSPANNUNG: NOMINAL VOLTAGE:	12 V	12 V oder/lor 12/24 V	12 V oder/lor 12/24 V
SPANNUNGSBEREICH: VOLTAGE RANGE:	9 - 16 V	9 - 16 V oder/lor 9 - 33 V	9 - 16 V oder/lor 9-33 V
LEISTUNG: POWER:			
	Positionsleuchte <i>position lamp</i>	0,3 Watt	
	Fahrtrichtungsanzeiger <i>direction indicator</i>	2,9 Watt (Klasse 1 class 1)	1,0 Watt
	Schlussleuchte <i>tail lamp</i>		0,3 Watt
	Bremsleuchte <i>stop lamp</i>		1,1 Watt
	Nebelschlussleuchte <i>fog lamp</i>		2,6 Watt
	Rückfahr-scheinwerfer <i>reversing lamp</i>		1,8 Watt
KABELTYPE: CABLE:	3 x 0,75 mm ² Mantelleitung 3 X 0,75 MM ² SHEATHED CABLE		
GEWICHT: WEIGHT:	100 g	120 g	120 g
ANBAU: MOUNTING POSITION:	360° 	360° 	horizontal / vertikal <i>horizontal / vertical</i> 
MATERIAL: MATERIAL:	PMMA		
TEMPERATURBEREICH: TEMPERATURE RANGE:	-30°C ~ +50°C		
IP-KLASSE: IP-RATING:	IP6K9K nur für die Beleuchtungseinheit <i>only for the lamp</i>		
EMV-ABNAHME: EMC APPROVAL:	R10		
DIMENSION: DIMENSION:	L= 168 mm, B= 33 mm, H= 20,5 mm		



Abmessung für Montageausschnitt
dimension for assembly cut out





















































Mittelpunkt für Schraube
center point for screw



BEST. NR PART NO		BEST. NR AM PART NO AM	← →			FUNKTIONEN FUNCTIONS	ZUSATZ ADD ON	ANSCHLUSS CONNECTOR	KABEL CABLE
32-7344-027	1/50	32-7344-024			12V	  		Lear 1664.559.699	0,20 m
33-7344-017	1/50	33-7344-014			12V 24V	  		offenes Ende open end	0,50 m
33-7344-047	1/68	33-7344-044			12V	  		4 pol. Deutsch ♂ 4 pin Deutsch	0,50 m
33-7344-027	1/50	33-7344-024			12V 24V	  		5 pol. Bajonett ♂ 5 pin Bayonet	0,20 m
32-7344-017	1/68	32-7344-014			12V 24V	 		offenes Ende open end	0,50 m



PIKTOGRAMM ÜBERSICHT PICTOGRAM OVERVIEW

	Verpackungseinheit packaging unit		Seitenmarkierungslicht + Reflektor sidemarker + reflector
	x Stück pro Karton x pieces per box		Positionslicht hinten rear position light
	links left		positionslicht vorne front position light
	rechts right		rot, weiß, orange red, white, amber
	Leuchtmittel light source		rot, weiß red, white
	Volt		rot red
	Umrissarm end outline marker		weiß white
	Glühbirne bulb		Umrissleuchte end outline marker
	LED		Rückstrahler rot reflector red
	Fahrtrichtungsanzeiger direction indicator		Rückstrahler gelb reflector amber
	Fahrtrichtungsanzeiger rechts direction indicator right		Rückstrahler weiß reflector white
	Fahrtrichtungsanzeiger links direction indicator left		Arbeitsscheinwerfer working lamp
	dynamischer Fahrtrichtungsanzeiger dynamic direction indicator		Kennzeichenbeleuchtung number plate lamp
	dynamischer Fahrtrichtungsanzeiger rechts dynamic direction indicator right		Rückfahralarm reverse alarm
	dynamischer Fahrtrichtungsanzeiger links dynamic direction indicator left		männlich male
	SMCG (Steuerung blinkender Seitenmarkierungsleuchten) SMCG (side marker control gear)		weiblich female
	mit integriertem Blink-LCG with integrated direction indicator LCG		Flood
	mit integriertem LCG2 with integrated LCG2		Spot
	Rücklicht tail light		horizontal Anbau horizontal mounting
	Bremslicht stop light		vertikal Anbau vertical mounting
	Nebelschlusslicht fog light		360° Anbau möglich 360° mounting possible
	Rückfahrlicht reverse light		... Lumen
	Dreieckrückstrahler triangle reflector		... Watt
	ohne Dreieckrückstrahler without triangle reflector		ADR Zone 2
	Positionslicht position light		IP xx Schutzklasse IP xx rating
	Seitenmarkierungslicht sidemarker light		
	Reflektor (Seitenmarkierungslicht) reflector (sidemarker light)		